

## COMPANY PROFILE

Your Specialist for Gearbox

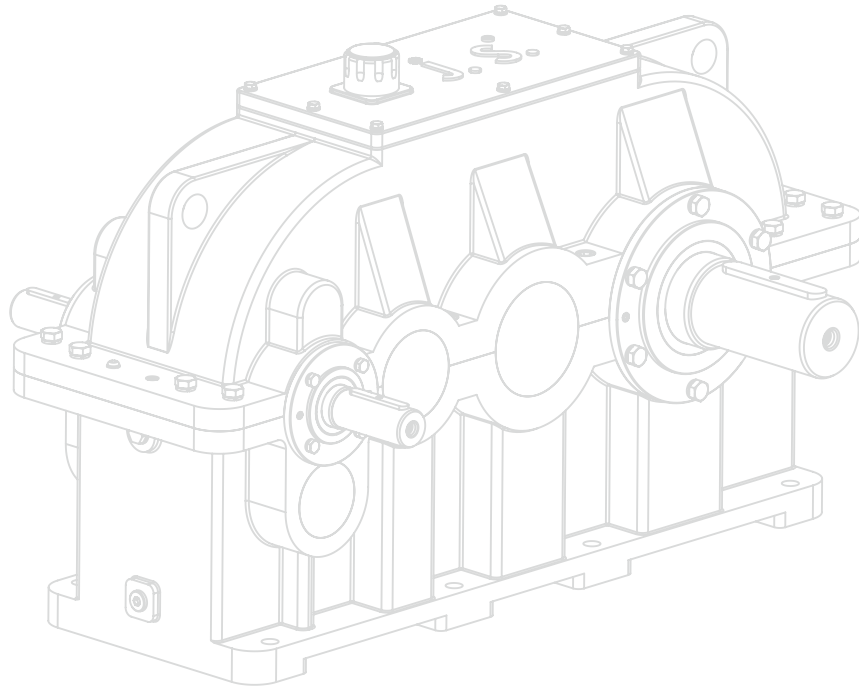

Since : 1990



## World-Class Custom Industrial Gearbox Manufacturers and Suppliers

We are a highly affordable gearbox manufacturer in India. Our cost-effective gearboxes are easy to operate and last long. We are the number one industrial gear motor manufactures with a flexible approach to adapt to the requirements of all our clients from any industry.





Since : 1990

## About JS

J.S. was established in 1990. Our modern manufacturing facility is in Ahmedabad. It is one of the largest companies in Gujarat that manufactures high-quality gearboxes under the brand name J.S. With over 34 years of vast and varied experience possessed by Mr J.S. Panchal (Founder of the company) and Mr Nirav Panchal (Promoter of the company), J.S. has now emerged as a reference point or proudly preferred product in this flourishing field.



# OUR EXCELLENCE



More than 34 Years  
of Presence & Experience

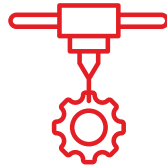

Rigid Design Based  
High Precision Manufacturing



High-Quality  
Raw Material

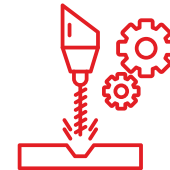

In-House Modern  
Manufacturing Facilities

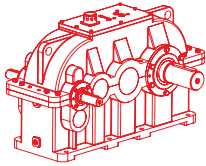

10,000 Helical Gearboxes  
Supplied over the World



300+ Domestic  
& International Clients



ISO 9001:2015  
Certified Company



Licensed SolidWorks &  
KISSsoft Design Softwares

# CERTIFICATIONS

We have qualified staff to make new designs, using latest softwares to design market need. Doing stress analysis on software, then design goes to shop floor.

The gear box is designed to satisfy requirements & conditions encountered in different process. High torque is required for many industries hence the gear unit is designed accordingly. We at J.S. bring to you the finest in gear & transmission technology.





**Chemical**



**Food Extruder**



**Material Handling**



**Paper**



**Rubber**

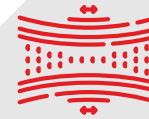

**Sugar**



**Dairy**



**Heavy Conveyor**

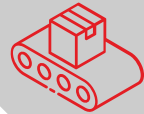

**Oil**



**Plastic**

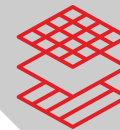

**Steel**



**Textile**



## UNIT-1

Dedicated Unit for Machine Shop  
(Size - 10,000 Square Feet)

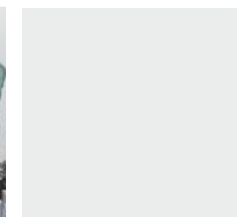
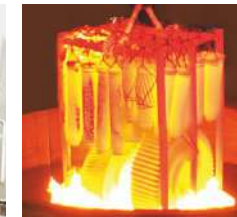

## UNIT-2

Dedicated Unit for Assembly & Store  
(Size - 12,000 Square Feet)

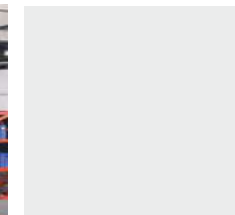
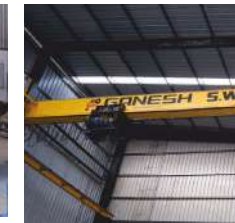





## UNIT-3

Dedicated Unit for Paint Shop and  
Dispatch Material  
(Size - 6000 Square Feet)

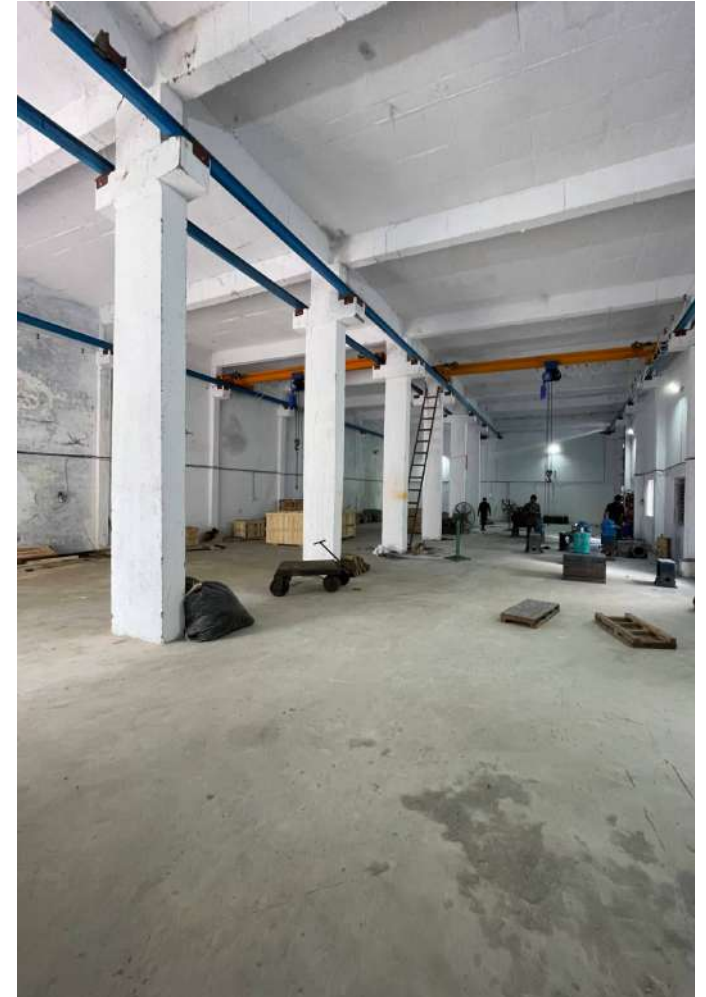

## Plant & Machinery

## MANUFACTURING CAPACITY

CNC Turning Machine (Upto 1 Meter Length) - 3 NOS

Gear Hobbing Machine (Upto 1000 MM Diameter) (Germany) - 5 NOS

Gear Grinding Machine (Upto 700 MM Diameter) (Germany and Swiss) - 5 NOS

HMC Machine (Japan) - 2 NOS

Boring Machine - 3 NOS

Round Bandsaw Machine (Upto DIA 420) - 2 NOS

Conventional Lathe Machine - 4 NOS

Radial Drill Machine (HMT Make) - 2 NOS

Slotting Machine (400 MM Stroke) - 2 NOS

Measuring Instruments - Mitutoyo Make

Milling Machine for Heavy Key Way (Germany) - 2 NOS

Surface Grinding Machine - 1 NOS

In-house Paint Shop

In-house Fabrication Work

Heavy Duty Hydraulic Press - 4 NOS

5 TON EOT Crane - 4 NOS + 2 TON EOT Crane 2 NOS

Automatic Key Way Machine - 2 NOS

Bore Key Way Broaching Machine (upto 32 Mm Key Way Size) - 1 NOS

VMC Machine - 1500 X 700 Mm Table Size



PRODUCT RANGE

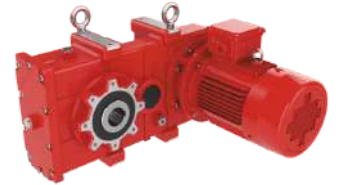
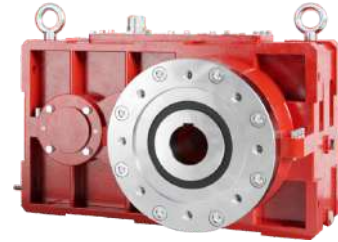

## **CRANE DUTY HELICAL GEARBOXES**

### Description

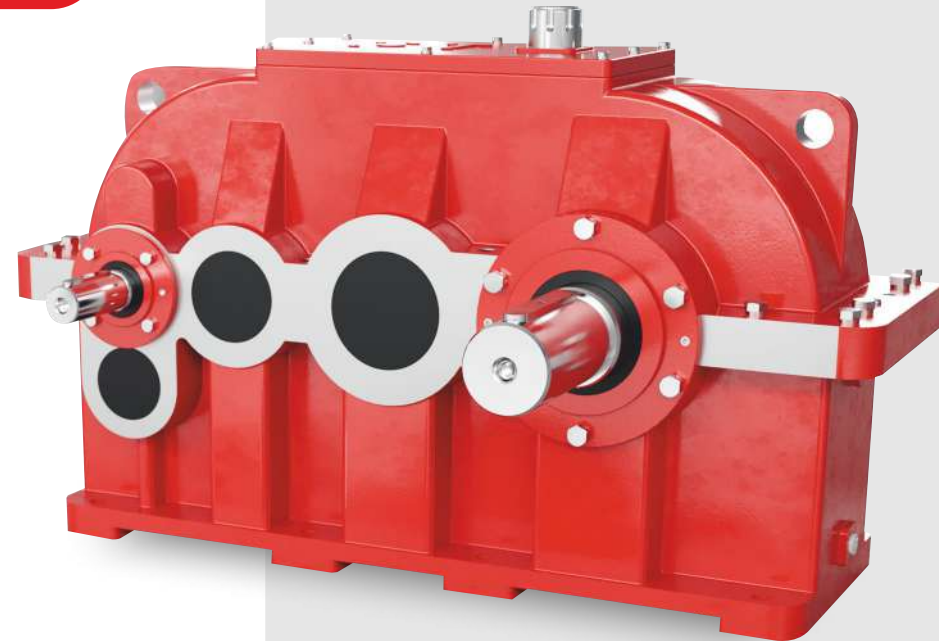

- ⚙️ **Crane duty helical gearboxes available in three & Four stages**
- ⚙️ **Sizes** : (Input to Output center) 250 to 1600 MM available
- ⚙️ **Gears** : High Graded Alloy Steel, Case Harden and Profile Ground
- ⚙️ **Bearing** : Roller Bearings
- ⚙️ **Available version** : Solid Standard shaft, Geared output shaft & Hollow output is also available
- ⚙️ **Case** : Cast Iron & Fabricated
- ⚙️ **Ratio** : Available up to 630:1



## PARALLEL SHAFT HELICAL GEARBOXES

### Description





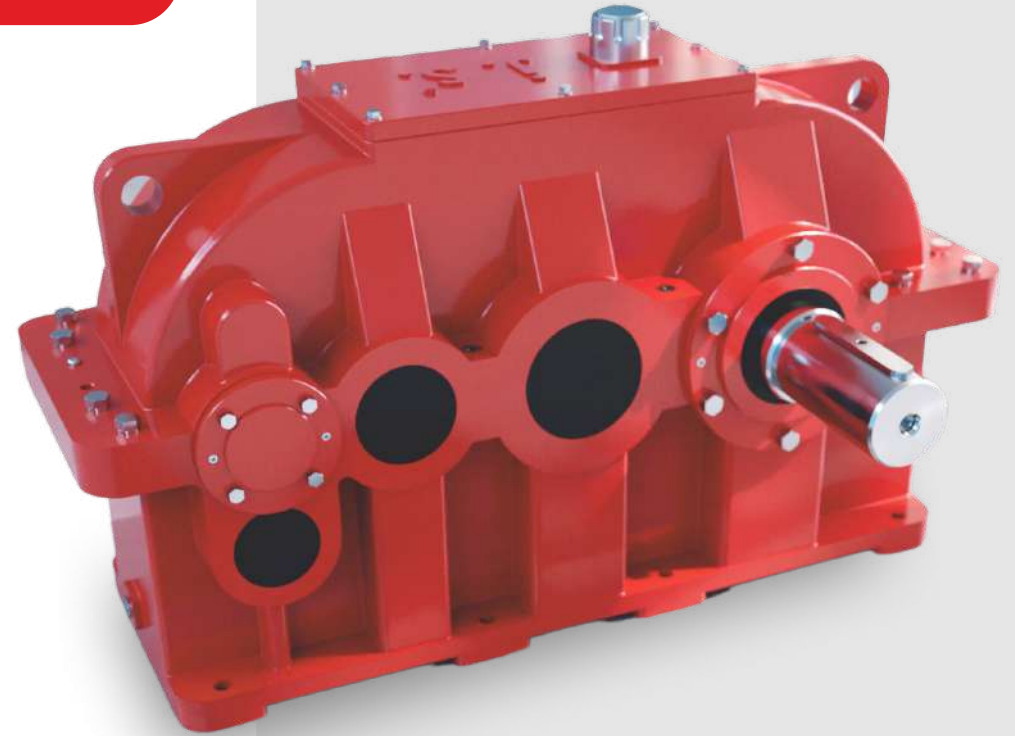





TYPES	SIZES	RATIO
HC – Three stage helical	100-630	25:1 to 150:1
HD – Four stage helical	200-630	150:1 to 650:1

-  **Power** : up to 500 KW
-  **Case** : Cast Iron & Fabricated
-  **Gear** : Made from high Graded Alloy Steel, Case Harden and Precision Profile Ground
-  **Bearing** : Roller Bearings



## K- SERIES HELICAL BEVEL GEARED MOTOR











### Broad Specification

 Model	: Output Hollow
 K-07	: 50MM
 K-08	: 60MM
 K-09	: 70MM
 K-10	: 90MM
 K-12	: 100MM
 Output Torque	: 180 N.m to 20000 N.m
 Gearbox Ratio	: 10:1 to 240:1 Available
 Input Hollow Frame IEC	: B5 type only available
 Input HP	: 2 HP to 75 HP
 Input Solid Shaft	: Available



## EXTRUDER DUTY HELICAL GEARBOXES





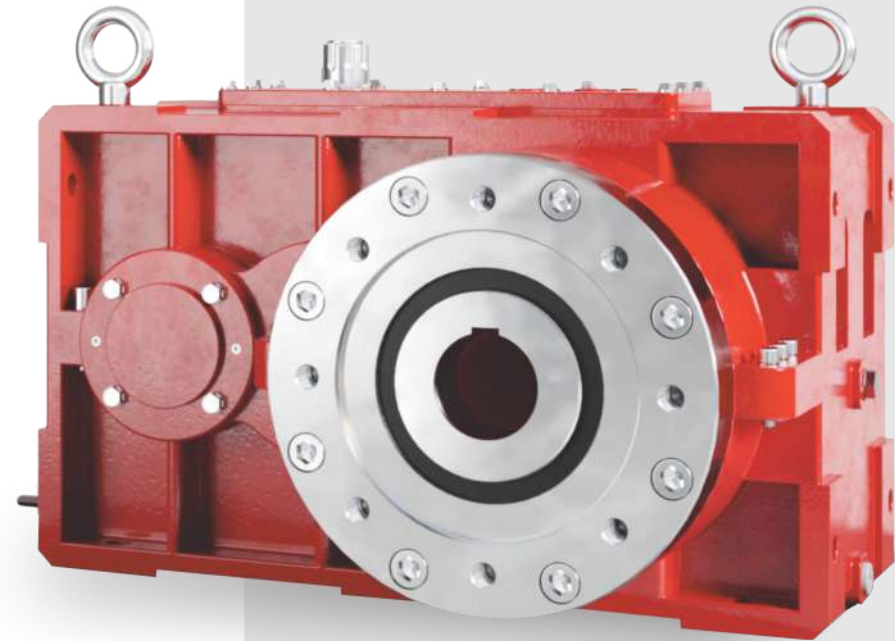

### Description

-  **Available Model** : SBH 90 / SBH 110 / SBH 125 / SBH 140 / SBH 160 / SBH 180 / SBH 200 / SBH 225 / SBH 250 / SBH 280 / SBH 315 / SBH 355
-  **Rigit Design**
-  **Available in** : Single stage & two stage Extruder duty Helical Gearboxes
-  **Ratio** : 6:1 To 22:1
-  **Case** : Graded cast Iron
-  **Gears** : Made from high graded alloy steel, harden and precision profile ground to meet higher standard
-  **Spherical thrust roller bearing 294 series & others are also roller bearings**
-  **Water cooling inbuilt**
-  **Oil Pump option available**
-  **Vertical models are also available**



## HT SERIES GEARED MOTOR

### Description



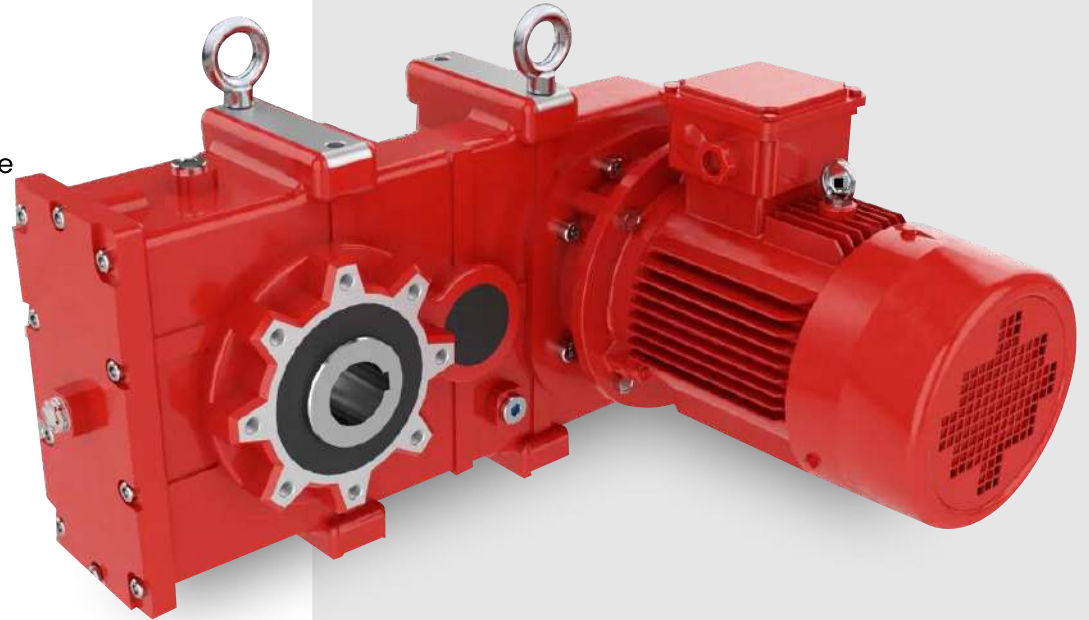



-  **Sizes** : 07, 08, 09
-  **Available version** : input and output hollow with extra output flange
-  **Case** : Graded cast Iron
-  **Power** : up to 30KW
-  **Ratio** : 63:1 / 80:1 / 100:1 / 130:1
-  **All Harden And Profile Ground Gears**





## M-SERIES INLINE HELICAL GEARED MOTOR







### Description

-  **Sizes available** : As per Output Shaft Diameter DIA 40, DIA 50, DIA 60, DIA 70, DIA 90, DIA 100, DIA 110, DIA 140
-  **Available Mountings** : Foot Mounting, Vertical Mounting, Input Solid Shaft
-  **Gear Case (Body)** : Cast Iron
-  **Power** : upto 40 kw
-  **Gearing with two & three reduction stages**
-  **Available Ratios** : 10:1 / 15:1 / 20:1 / 25:1 / 30:1 / 36:1 / 42:1 / 50:1 / 60:1 / 70:1 / 80:1 / 90:1 / 100:1



## TWO STAGE HELICAL GEARBOXES HEAVY DUTY TYPE

### Description

-  **Crane duty helical gearboxes available in three & Four stages**
-  **Sizes** : H2-90 / H2-110 / H2-125 / H2-140 / H2-160 / H2-180 /  
H2-200 / H2-225 / H2-250 / H2-280 / H2-315 / H2-350 /  
H2-375 / H2-450 / H2-500
-  **Gears** : High Graded Alloy Steel, Case Harden and Profile Ground
-  **Bearing** : Roller Bearings
-  **Available version** : Input and Output Solid  
Optional Output Hollow
-  **Case** : Cast Iron & Fabricated
-  **Ratio** : 6.3:1 / 8:1 / 10:1 / 13:1 / 16:1 / 20:1 / 24:1

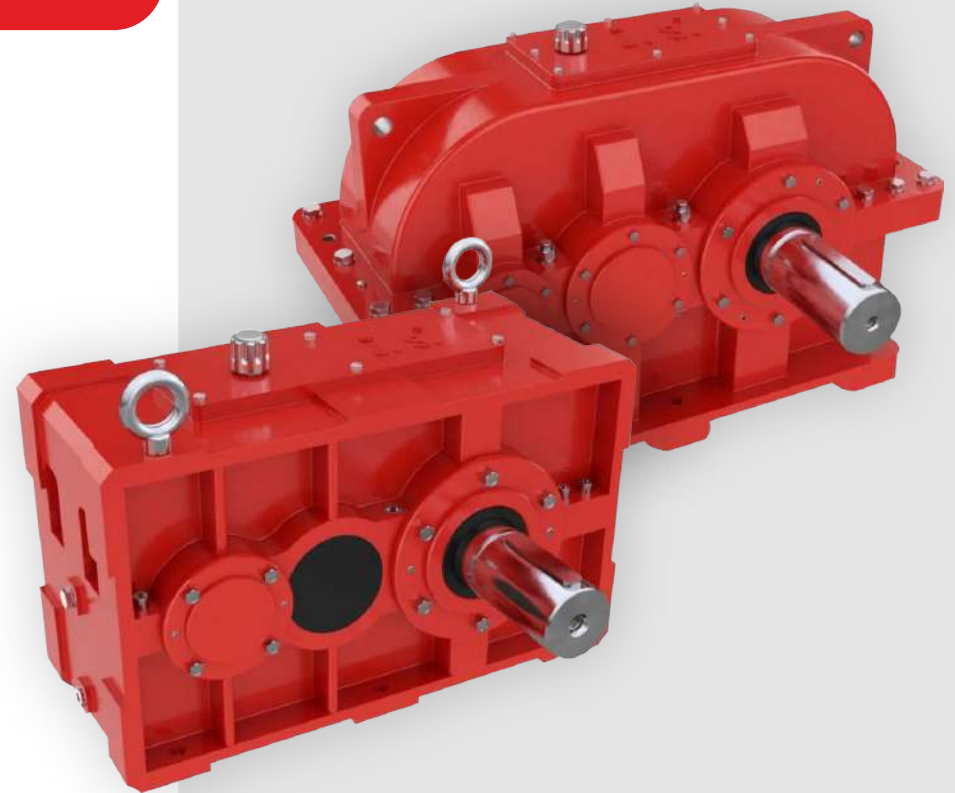

## CUSTOM MADE GEARBOXES

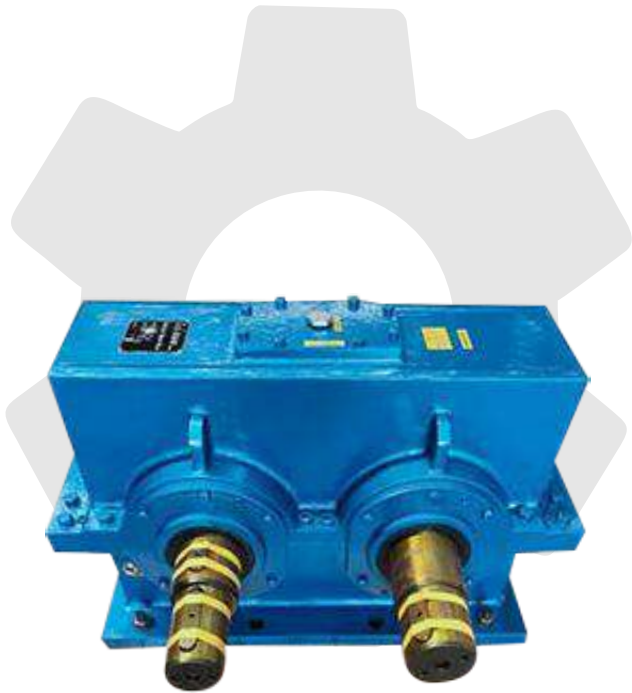

Customized Design as per Client's Requirements

## DROP-IN REPLACEMENT

### Description

J.S Gear proudly announces the launch of our new drop-in replacement for helical gearboxes. Our gearboxes are expertly designed and manufactured to seamlessly replace any brand or application, providing a highly reliable solution. Casing Fabricated and DIN-6 quality profile ground gears. If you're considering upgrading your old gearboxes.



# WHY RE-FURBISHMENT GEARBOXES



- ⚙️ Cost-effective alternative to purchasing new gearboxes
- ⚙️ Improve gear functionality and extend life span
- ⚙️ Increases reliability and extends lifespan of existing equipment
- ⚙️ Offers opportunity to upgrade and improve performance
- ⚙️ Faster turnaround time than ordering new gearboxes
- ⚙️ May require less downtime for installation compared to new equipment
- ⚙️ Save more on gear components compared to existing brands
- ⚙️ No matter what type of gearbox is in need of repair, we'll get it done quickly

## BEFORE



## AFTER



## BEFORE









## AFTER



## TWO STAGE HELICAL GEARBOXES HEAVY DUTY TYPE

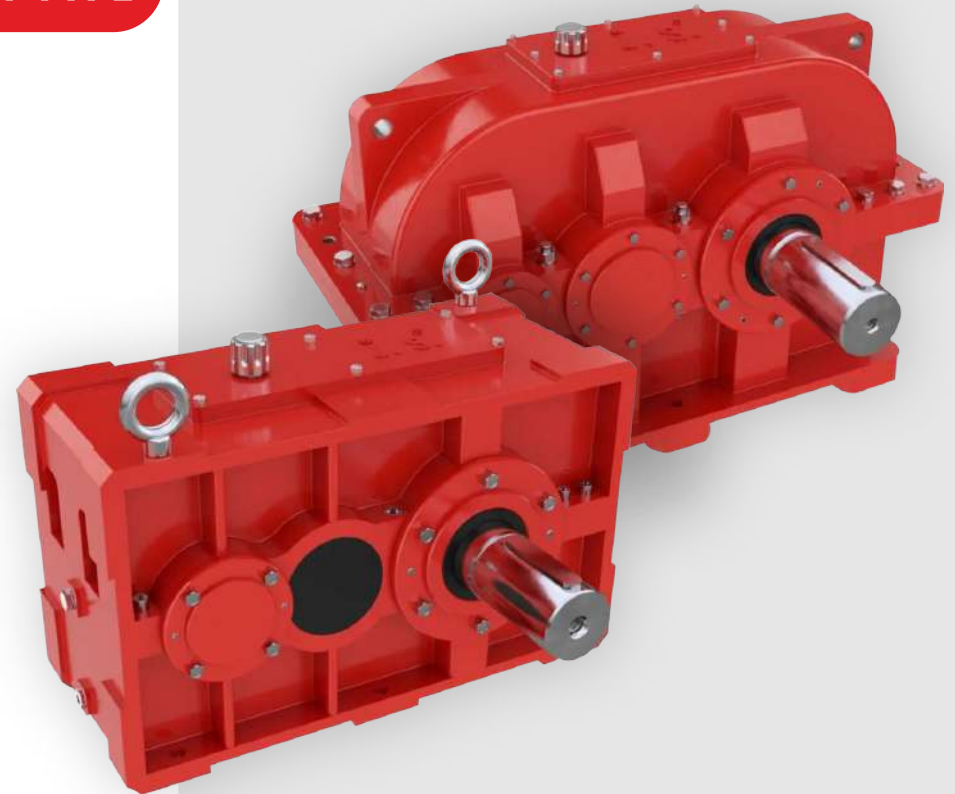

### Description

-  **Crane duty helical gearboxes available in three & Four stages**
-  **Sizes** : H2-90 / H2-110 / H2-125 / H2-140 / H2-160 / H2-180 /  
H2-200 / H2-225 / H2-250 / H2-280 / H2-315 / H2-350 /  
H2-375 / H2-450 / H2-500
-  **Gears** : High Graded Alloy Steel, Case Harden and Profile Ground
-  **Bearing** : Roller Bearings
-  **Available version** : Input and Output Solid  
Optional Output Hollow
-  **Case** : Cast Iron & Fabricated
-  **Ratio** : 6.3:1 / 8:1 / 10:1 / 13:1 / 16:1 / 20:1 / 24:1





 **LOOSE GEARS**

**HELICAL/SPUR GEAR WHEEL**

-  **Dia** : Upto 300mm
-  **Width** : Upto 350mm
-  **Module** : Upto 30mm

**PINION SHAFT**

-  **Dia** : Upto 500mm
-  **Length** : Upto 1600mm
-  **Module** : Upto 30mm





Since : 1990

CONTACT US

**J.S. GEAR**

51, Saundarya Industrial Park,  
Bakrol-Bujrang Village, Tal.: Daskroi,  
Dist.: Ahmedabad-382 430. Gujarat

+91 72111 28033

[jsgears@jsgears.in](mailto:jsgears@jsgears.in)

[www.jsgears.in](http://www.jsgears.in)

THANK YOU